

Jvm oczami Oracle

Sebastian Rabej

O Mnie

Programista

Zakochany w Javie

Lubi metodyki zwinne

Szuka definicji bycia „profesjonalnym”

Mail: [SebastianRabiej\[AT\]o2.pl](mailto:SebastianRabiej@o2.pl)



Chęć profesjonalizmu wpędza w kłopoty

Chęć profesjonalizmu wpędza w kłopoty



Sebastian Rabiej

Chęć profesjonalizmu wpędza w kłopoty

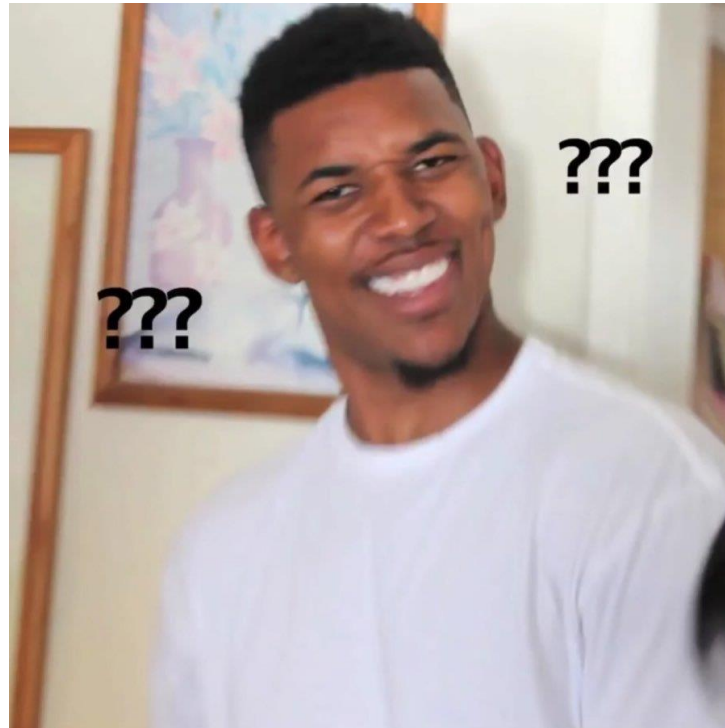

Sebastian Rabiej

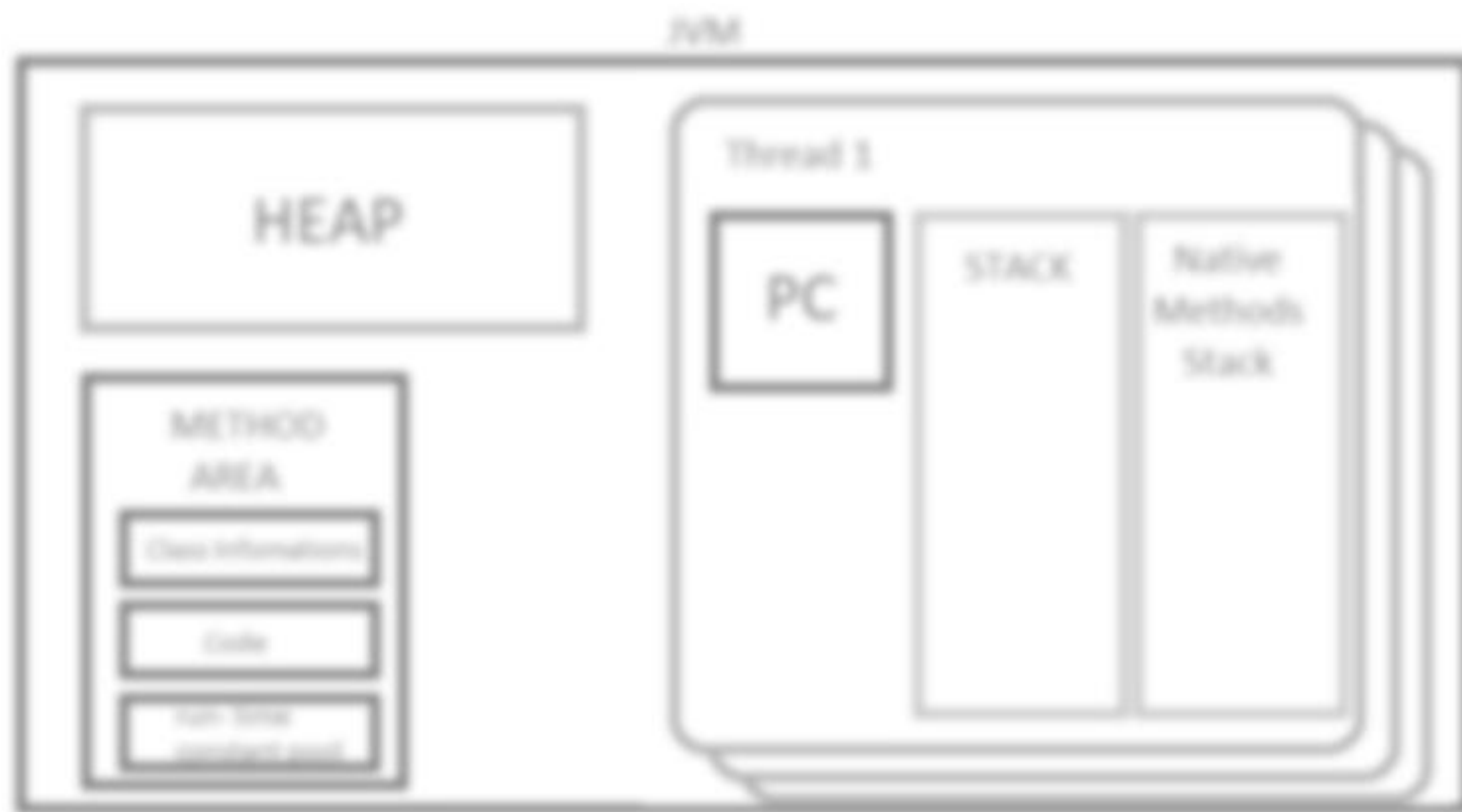

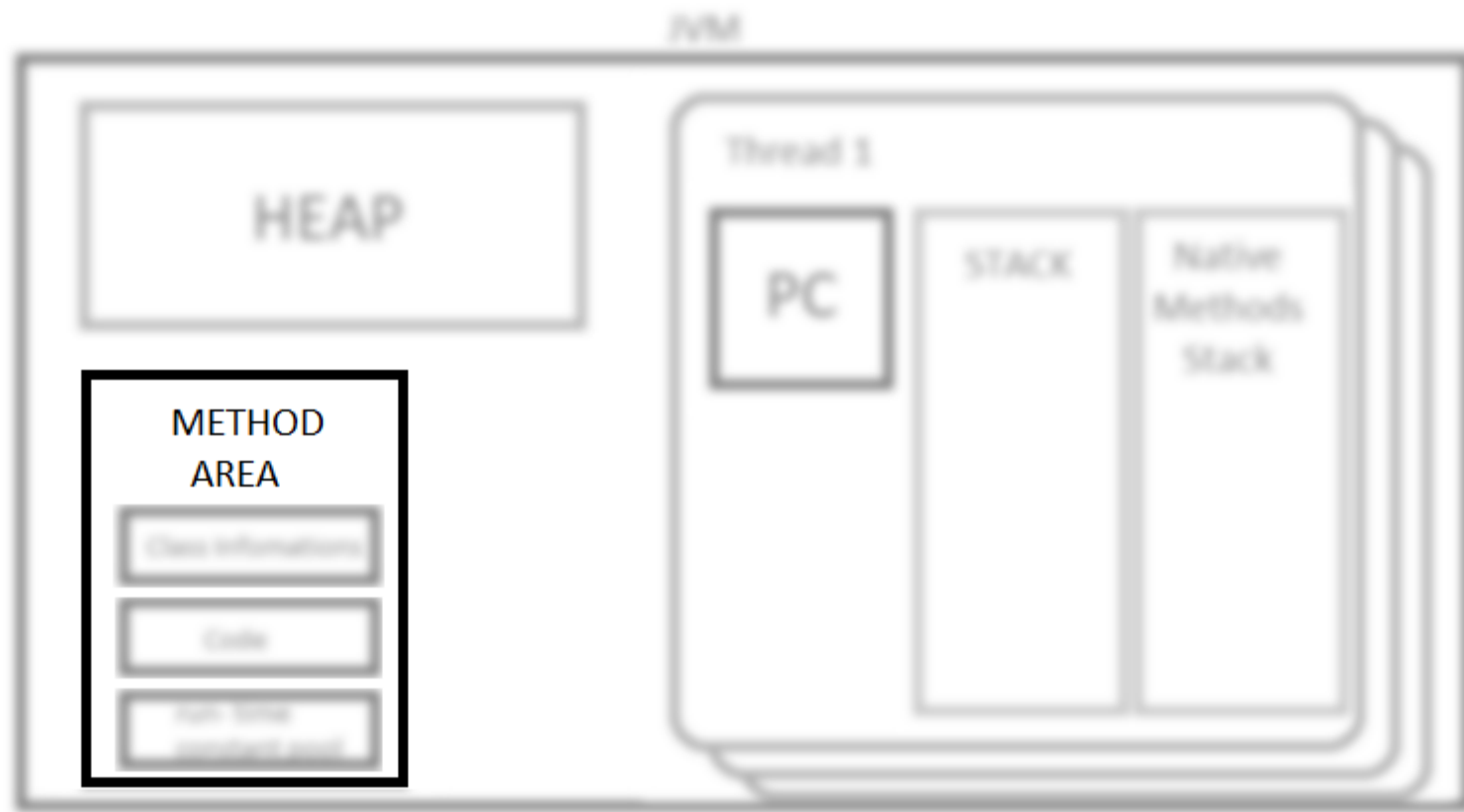

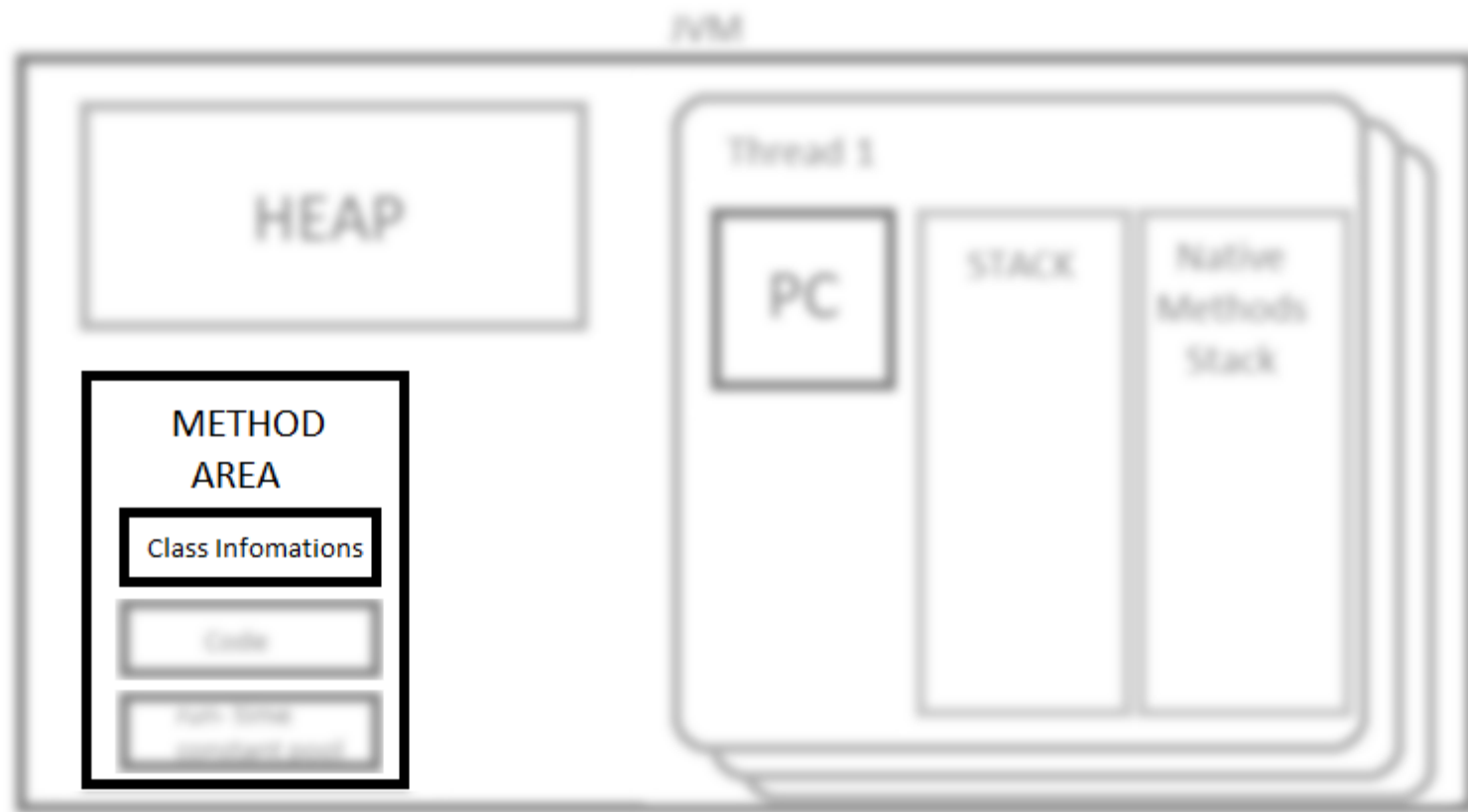

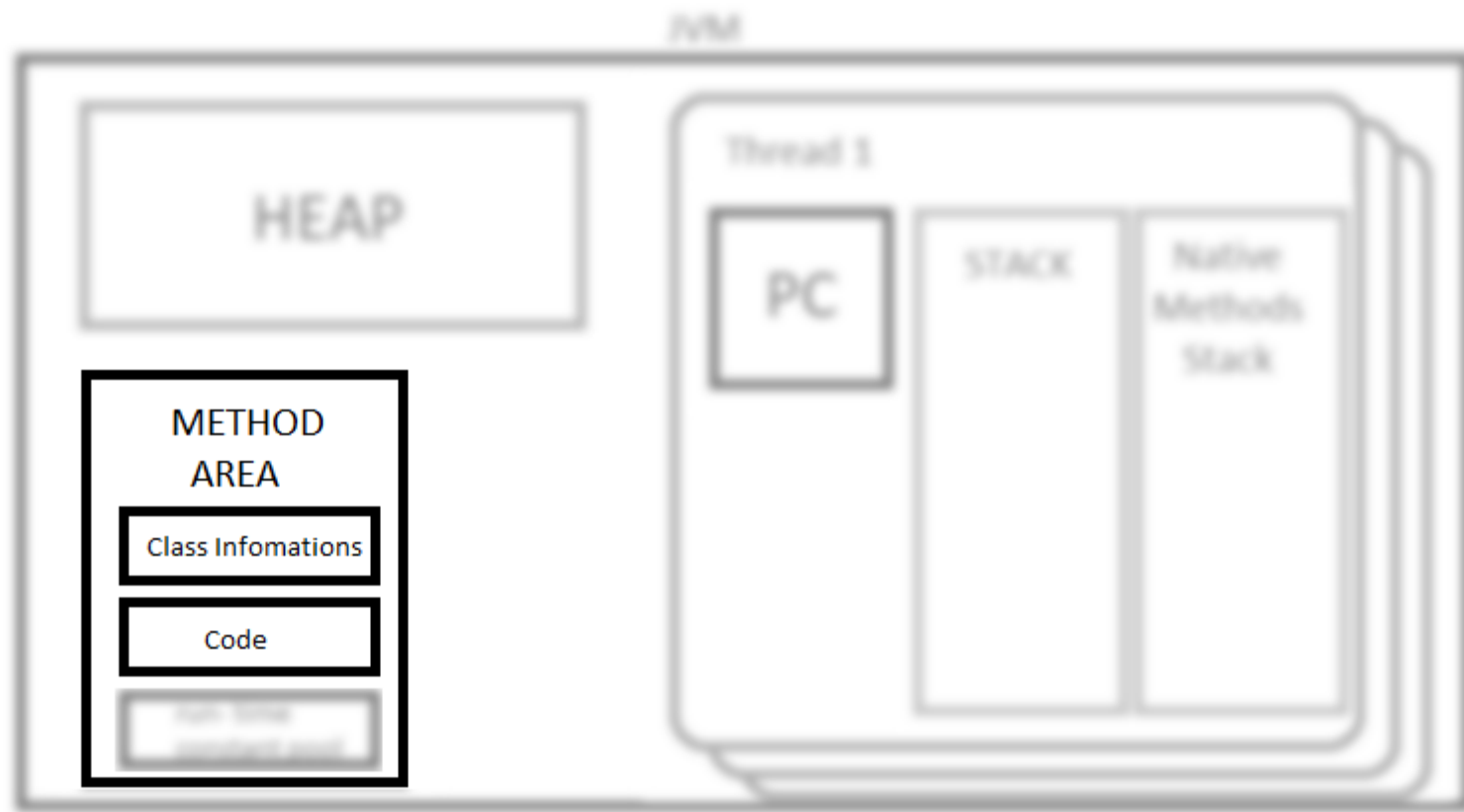

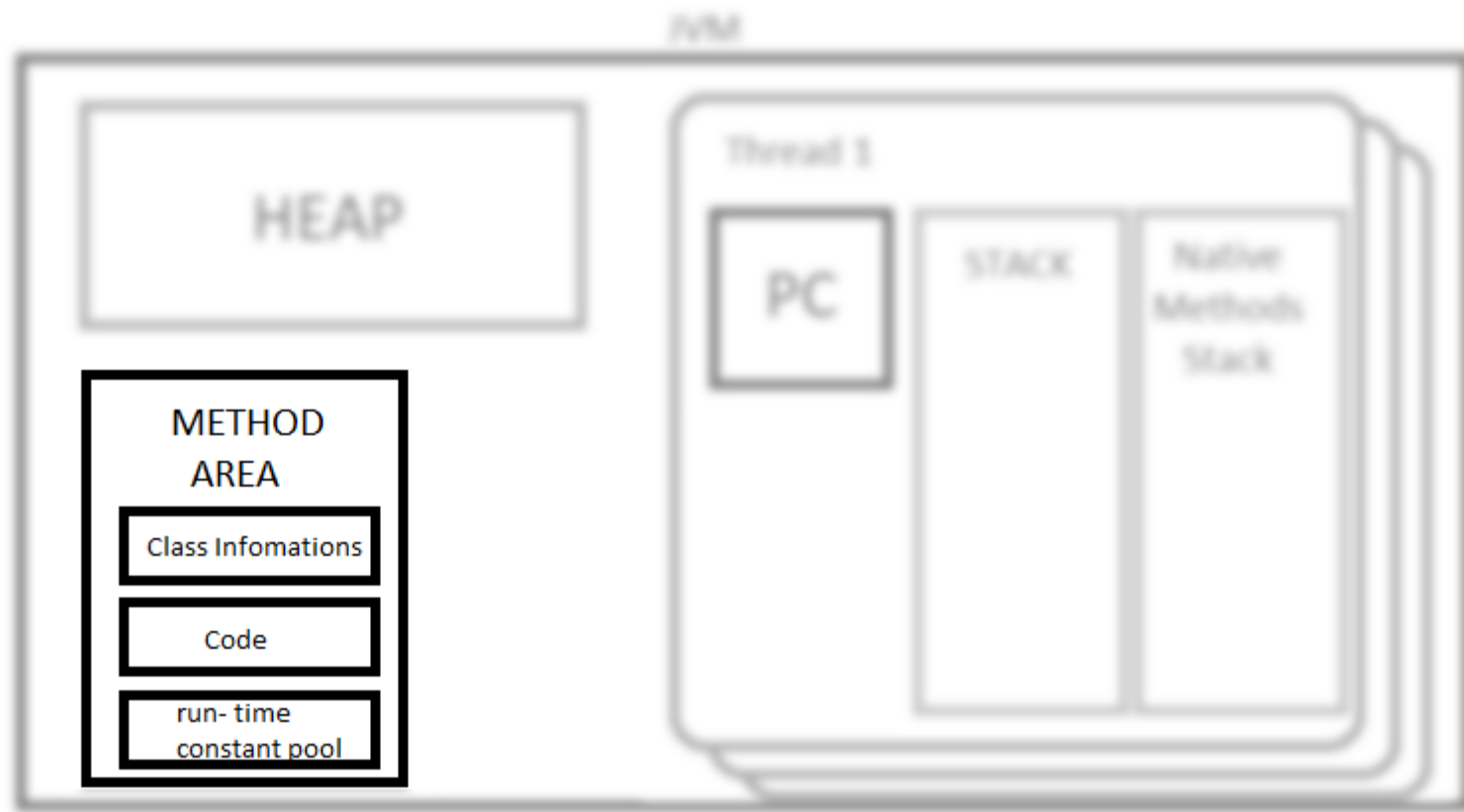

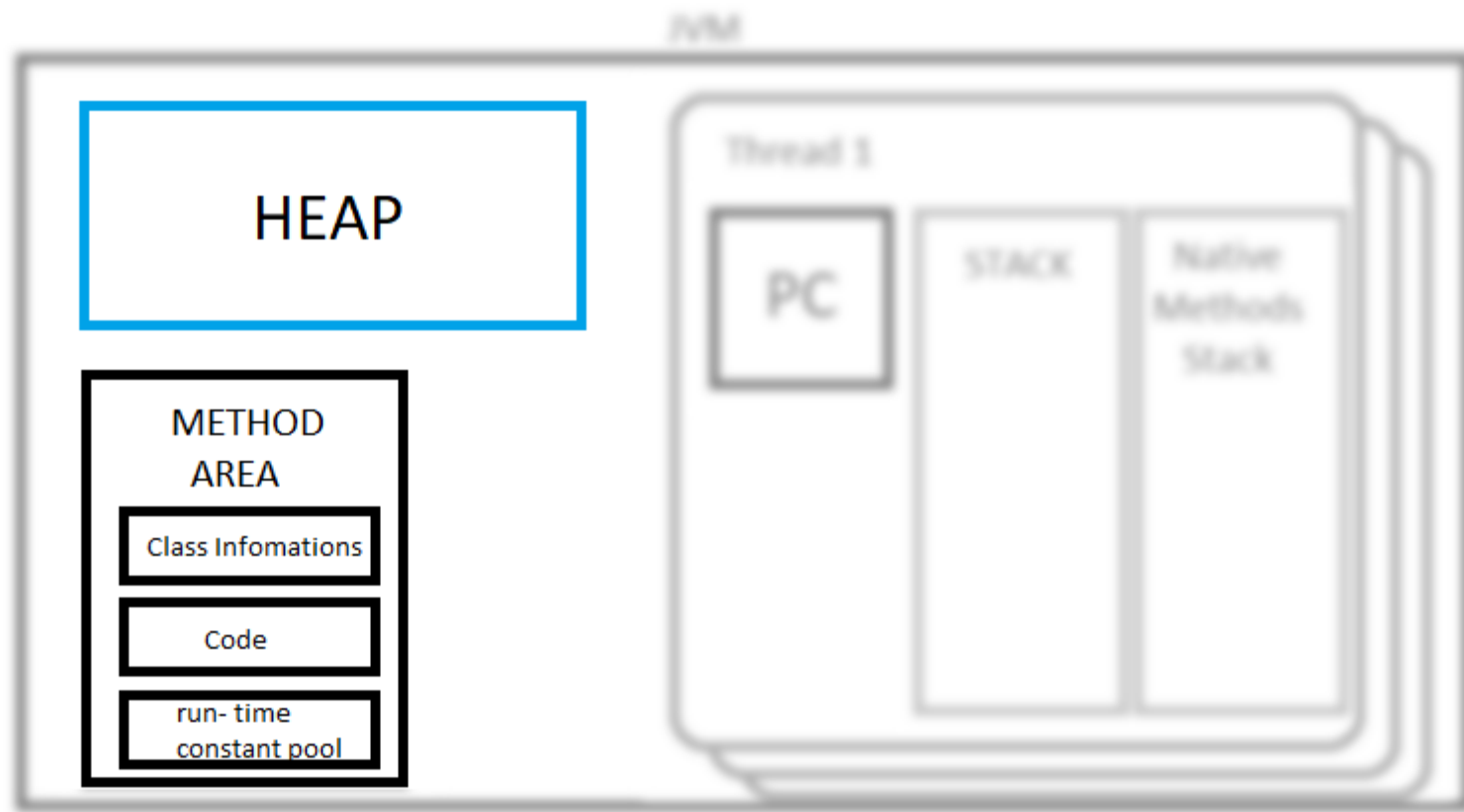

HEAP

Java 7



Java 8

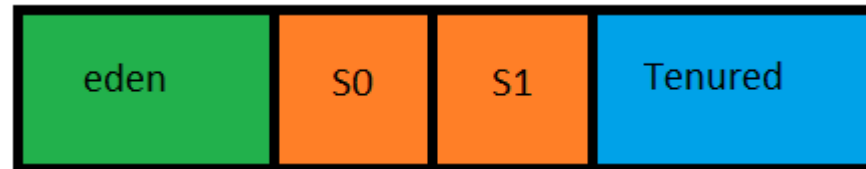

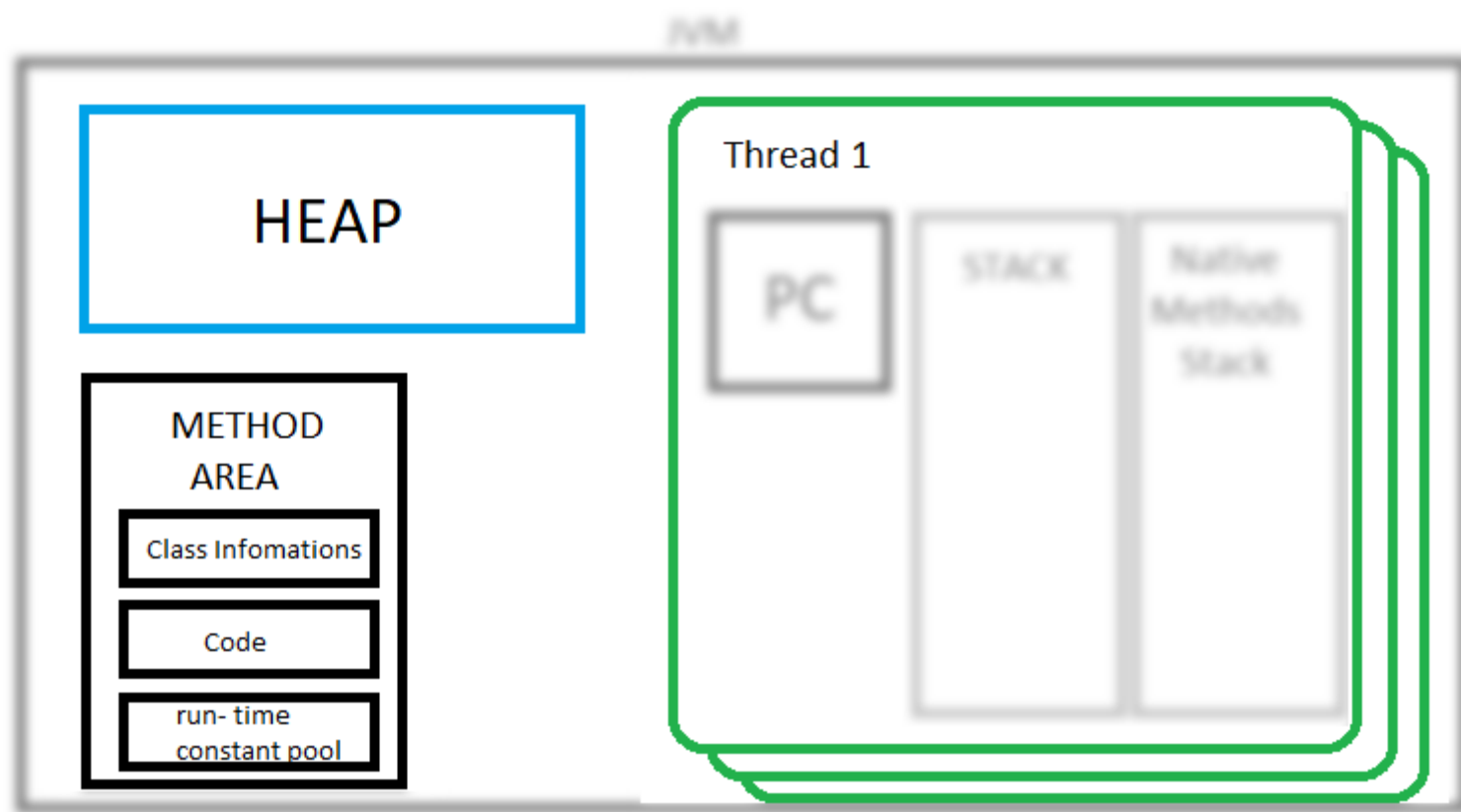

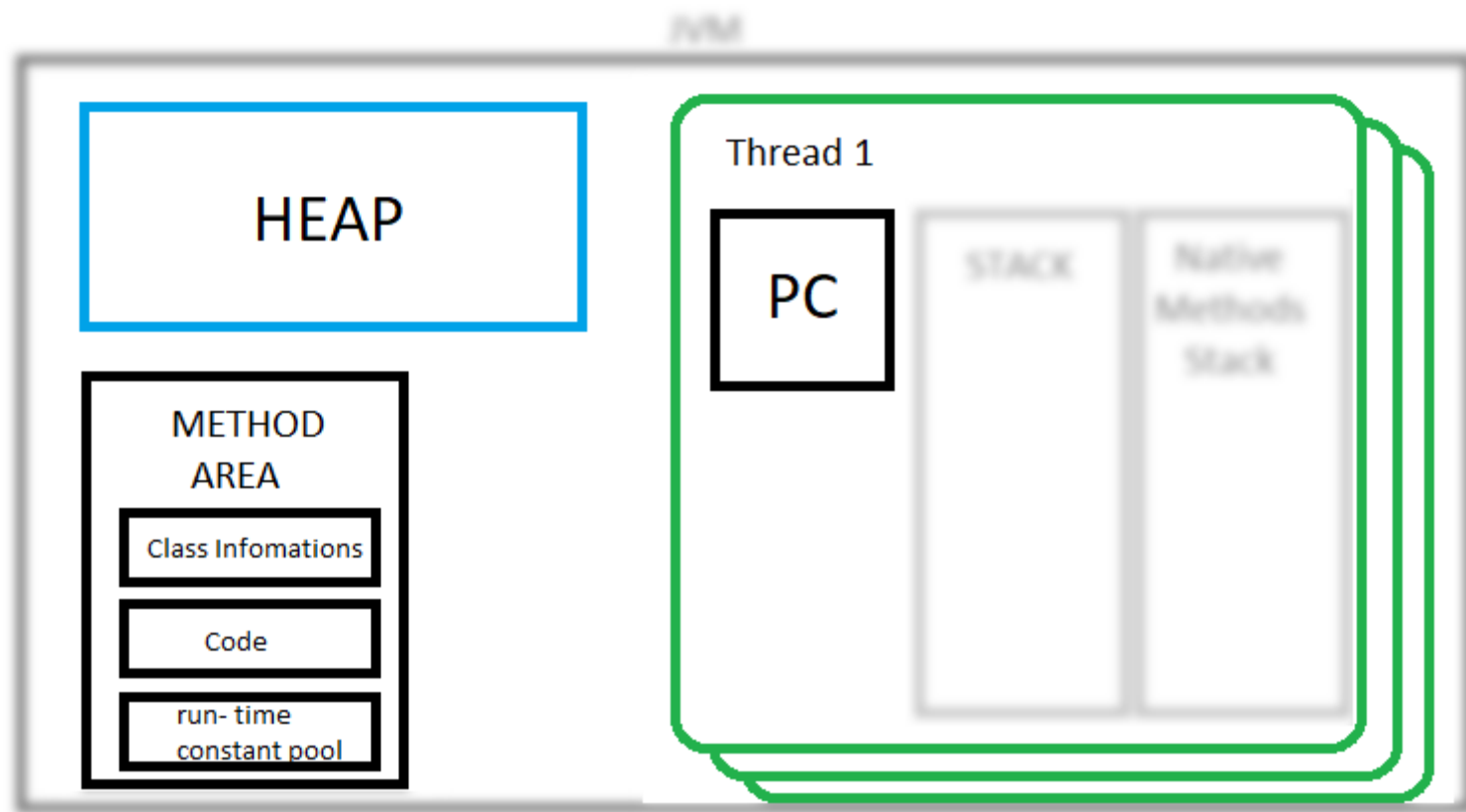

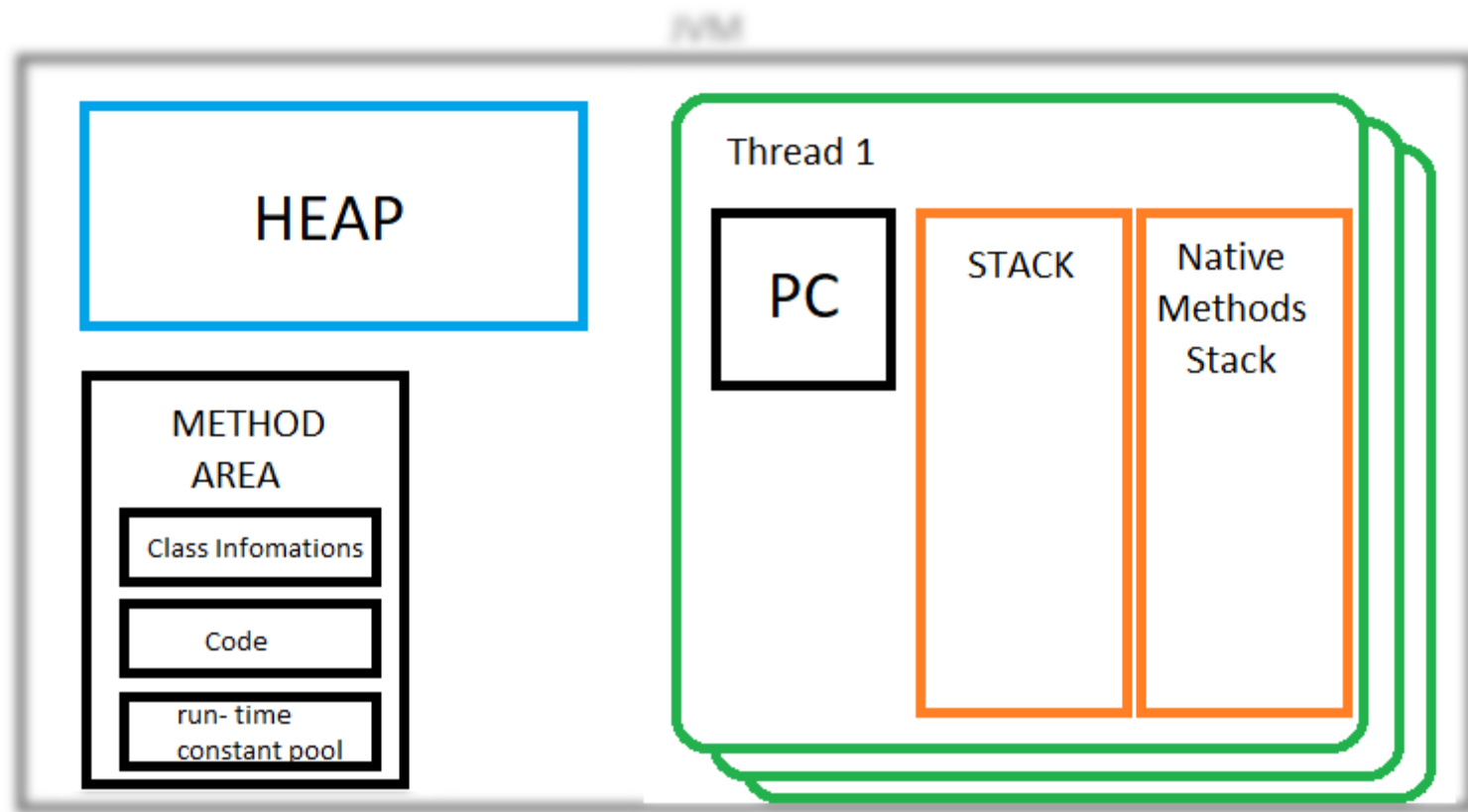

Ramka

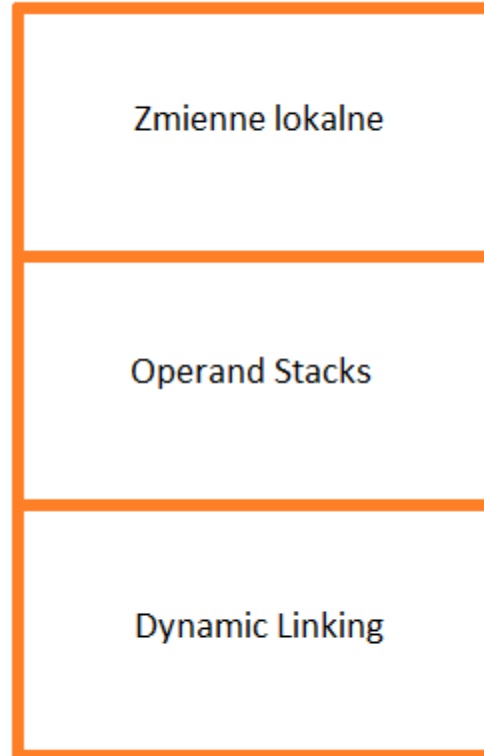

Przykład: 5+1

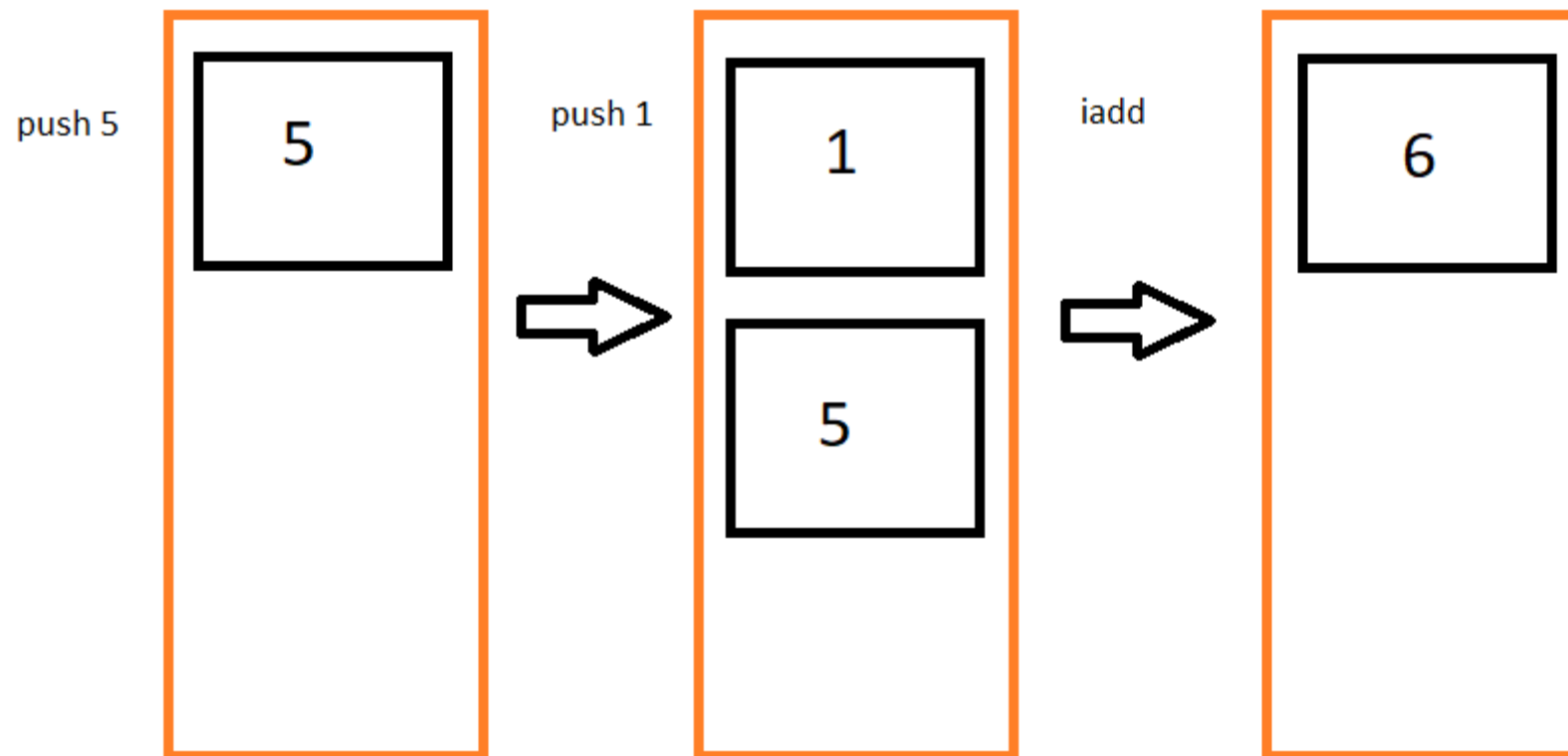

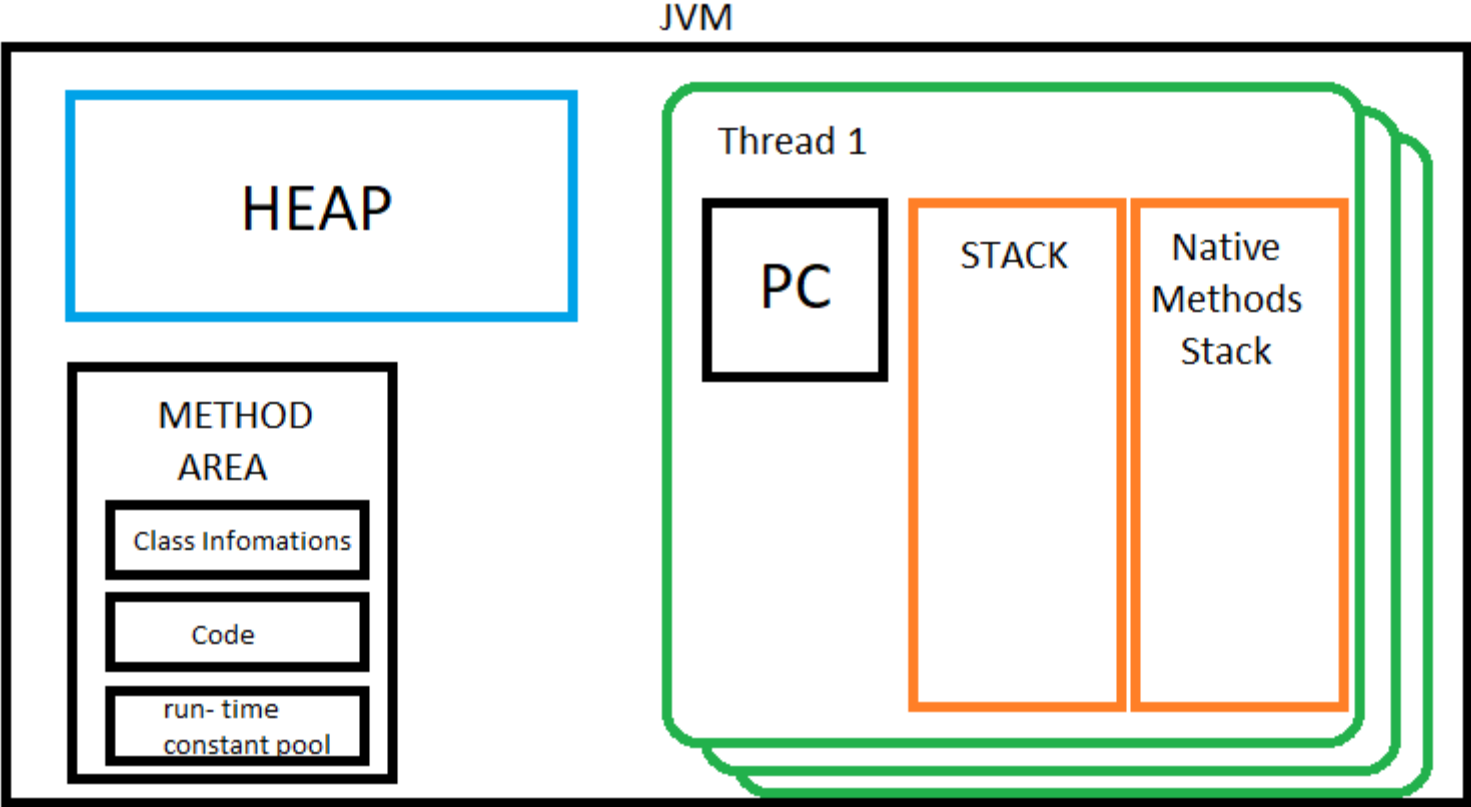

O czym nie powiedziałem?

- JIT (Just in Time)
- GC (Garbage Collector)
- ClassLoader

Q & A

Dziękuję



Sebastian Rabiej